

MODEL: 4LBS3030

REMODELER

ALL ACCESSORIES OPTIONAL

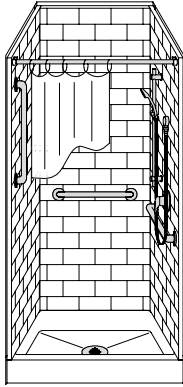

PERSPECTIVE VIEW - N.T.S.

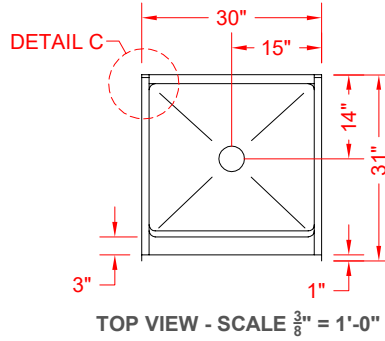

TOP VIEW - SCALE $\frac{3}{8}'' = 1'-0''$

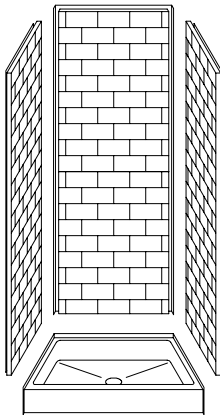

ASSEMBLY VIEW - N.T.S.

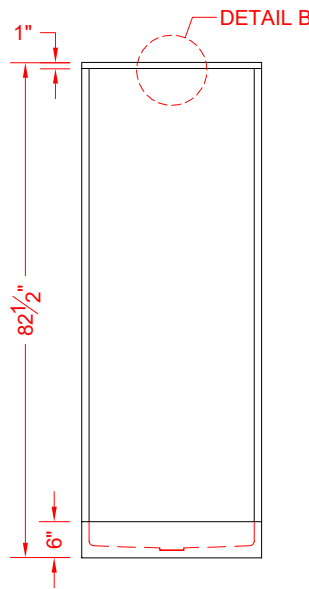

FRONT ELEVATION - SCALE: $\frac{3}{8}'' = 1'-0''$

* - SEE BACK FOR DETAIL SECTIONS

Features:

- Four-piece gelcoat/fiberglass shower module
- "Subway Tile", 4" x 8" simulated tile wall finish, white (standard)
- Integral full wood backing for strength and unlimited accessory placement
- Easy in-place installation from the front
- The authentic look of ceramic tile without the grout

PRODUCT SPECIFICATIONS:

- Multi piece shower module shall be constructed of gelcoat/fiberglass with full integral plywood backing in the walls
- Door opening: 27-3/8" x 75"
- Rough-In: Stud opening +1/4" -0" Nominal Dimensions.
- C.S.I. FORMAT SPECIFICATION TEXT AVAILABLE

PRODUCT INFORMATION:

- Accessories: Polished chrome/satin stainless standard, others available.
- Colors: White as standard, others to match any major fixture manufacturer, also available with sprayable solid surface in many colors

ACCESSORIES:

- INSTALLED BY OTHERS:**
- Mixing valve, pressure balanced, lever handle, preplumbed tee to supply elbow
 - Curtain and rod
 - Caulkless drain
 - Grab bar
 - Soap dish

CODES:

- Designed and manufactured in compliance with the following standards and codes:
- A.N.S.I. Z124.2 Standards for Plastic Showers

NOTICE OF LIMITATION:

Does not meet International Plumbing Code or Uniform Plumbing Code



Architectural Products for Barrier Free Living

www.barrierfree.org

(877) 717-7027

We reserve the right to make revisions without notice in the design of fixtures or in packaging unless this right has specifically been waived at the time the order is accepted.

REMODELER

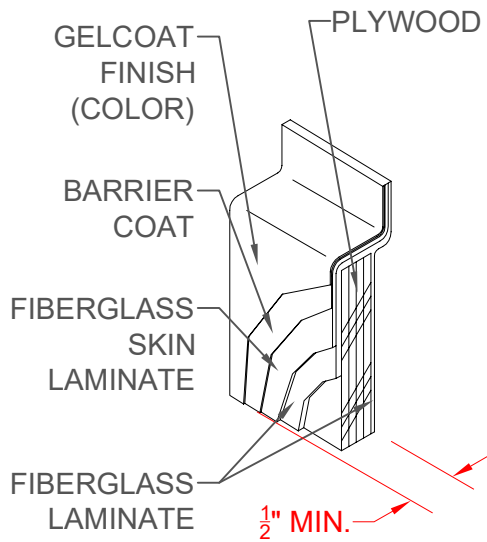

DETAIL B - SCALE: NTS
WALL SECTION DETAIL

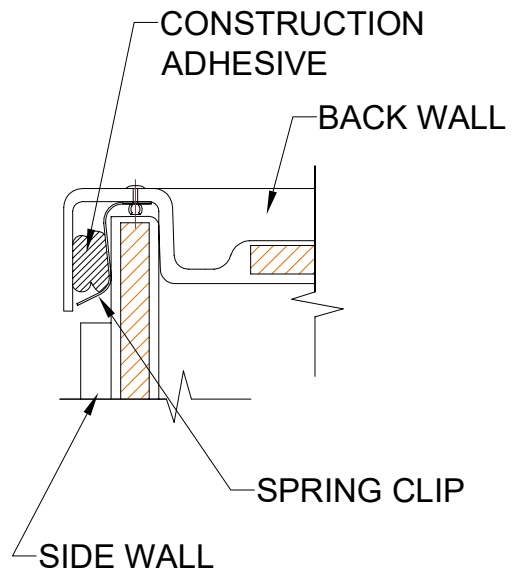

DETAIL C - SCALE: NTS
BACKWALL JOINT DETAIL

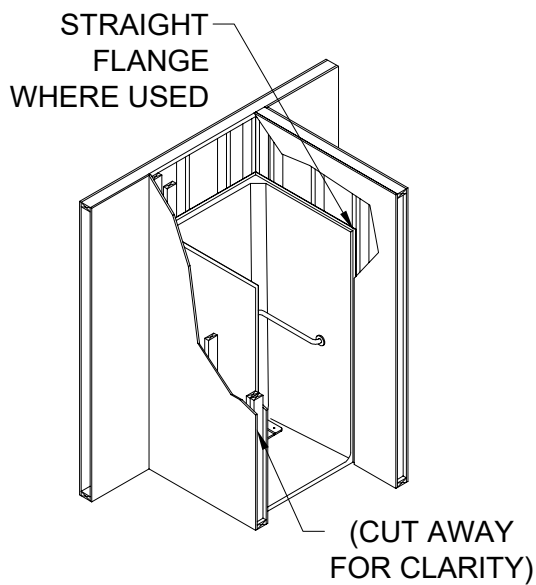

DETAIL D - SCALE: NTS
TYPICAL FRAMING