

MODEL: LCS6333A75T*

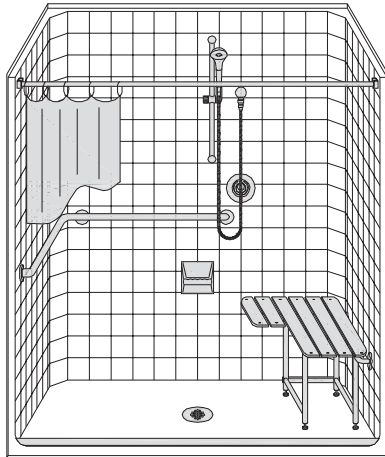

**PERSPECTIVE VIEW - N.T.S.
MODEL SHOWN HERE AS:**

RIGHT SEAT
RIGHT PLUMBING

ALL ACCESSORIES OPTIONAL

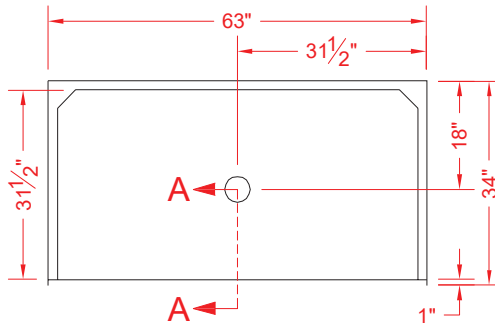

TOP VIEW - SCALE $\frac{3}{8}$ " = 1'-0"

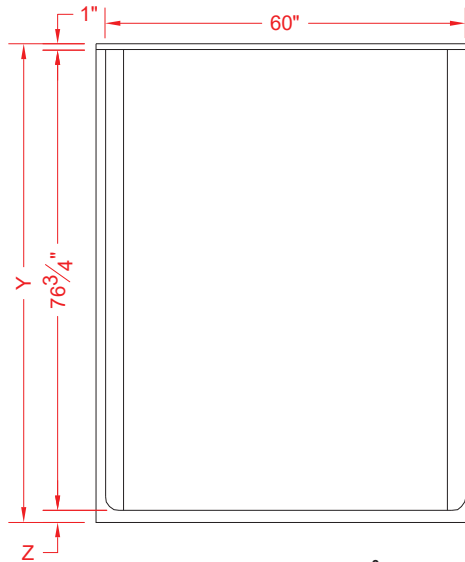

FRONT ELEVATION - SCALE: $\frac{3}{8}$ " = 1'-0"



Features:

- ADA compliant roll-in shower
- Available in various threshold heights
- Molded, one piece gelcoat/fiberglass shower module
- "Classic Tile" wall finish, white (standard)
- Integral full wood backing for strength and unlimited accessory placement
- On all threshold heights 1-1/2" or taller, no mud set is required
- On all threshold heights 1-1/4" or shorter, no mud set is required, but an epoxy adhesive kit is supplied

*OTHER THRESHOLD HEIGHTS AVAILABLE UPON REQUEST

	UNIT HEIGHT	THRESHOLD HEIGHT
MODEL #	Y	Z*
LCS6333A75T	78-3/8"	3/4" MIN.
LCS6333A2T	79-3/4"	2" MAX.

* - SEE BACK FOR DETAIL SECTIONS

PRODUCT SPECIFICATIONS:

- One piece shower module shall be constructed of gelcoat/fiberglass with full integral plywood backing
- Rough-In: Stud opening +1/4" -0" Nominal Dimensions.

C.S.I. FORMAT SPECIFICATION TEXT AVAILABLE

PRODUCT INFORMATION:

- Accessories: Factory installed, unless prone to damage during installation/shipping. Polished chrome/satin stainless standard, others available.
- Colors: White as standard, others to match any major fixture manufacturer, also available with sprayable solid surface in many colors
- Custom curb heights, other than shown, are available (between min. and max.)

ACCESSORIES:

INSTALLED AT FACTORY:

- Grab bar
- Seat, folding
- Mixing valve, pressure balanced, lever handle, preplumbed tree to supply elbow
- Vacuum breaker
- Soap dish

INSTALLED BY OTHERS:

- Curtain and rod
- T-Shaped Rubber WaterStopper Kit
- Semi-permanent Threshold Adaptor
- Caulkless drain

CODES:

- Designed and manufactured in compliance with the following standards and codes:
- A.N.S.I. Z124.2 Standards for Plastic Showers
 - I.P.C. International Plumbing Code
 - A.D.A. Accessibility Guidelines for Buildings and Facilities
 - A.N.S.I. A117.1 Accessible and Usable Buildings and Facilities
 - U.P.C. Uniform Plumbing Code

NOTICE OF LIMITATION:

- Recess as needed to meet code
- Adhere to floor as required



Architectural Products for Barrier Free Living

www.barrierfree.org (877) 717-7027

We reserve the right to make revisions without notice in the design of fixtures or in packaging unless this right has specifically been waived at the time the order is accepted.

LCS6333A75T

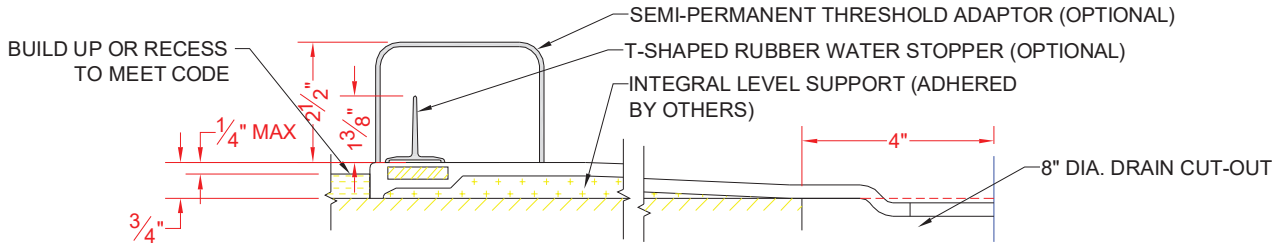

SECTION A-A - SCALE: 3" = 1'-0"

LCS6333A2T

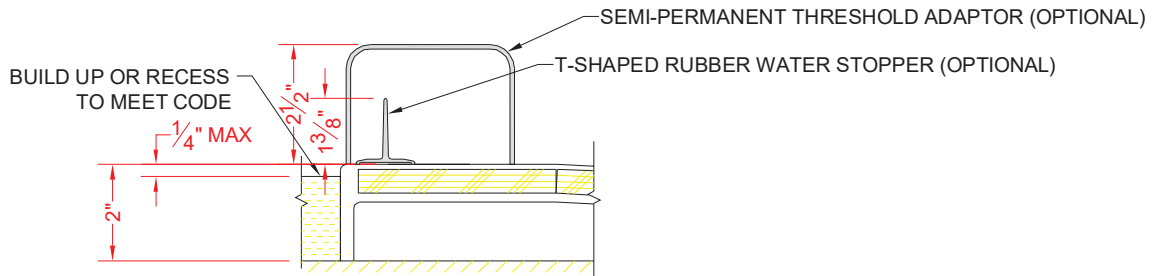

SECTION A-A - SCALE: 3" = 1'-0"

****OTHER THRESHOLD HEIGHTS AVAILABLE UPON REQUEST****

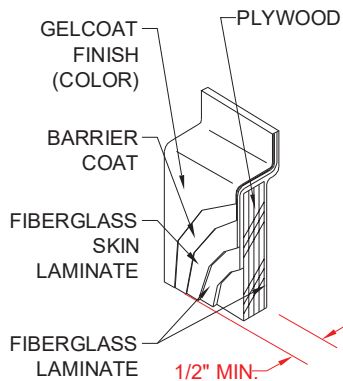

DETAIL B - SCALE: 3" = 1'-0"
WALL SECTION DETAIL

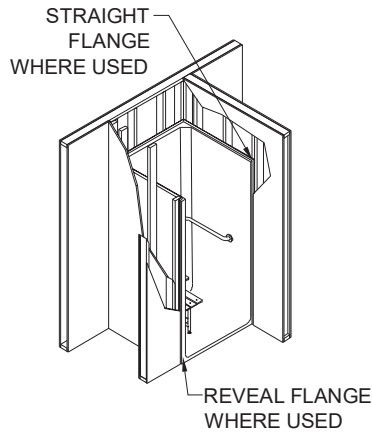

DETAIL C - SCALE: NTS
TYPICAL FRAMING